

PROJECTA

6/12/24V 40A 8 STAGE AUTOMATIC

WORKSHOP

CHARGER & BATTERY MANAGER



P/No. HDBM4000

IMPORTANT SAFETY INFORMATION

Please read this manual thoroughly before use and store in a safe place for future reference.

WARNINGS

- Explosive gases. Prevent flames and sparks. Provide adequate ventilation during charging.
- Before charging, read the instructions.
- For indoor use. Do not expose to rain.
- For charging lead acid batteries ONLY (of the size & voltage specified in the specifications table).
- Always charge the battery on the correct voltage setting. Never set the charger to a higher voltage than the battery.
- Disconnect the 240V mains supply before making or breaking the connections to the battery.
- The battery charger must be plugged into an earthed socket-outlet.
- Connection to supply mains is to be in accordance with National wiring rules.
- Do not attempt to charge non-rechargeable batteries.
- Never charge a frozen battery.
- If the AC cord is damaged do not attempt to use. It must be replaced or repaired by a qualified person.
- Corrosive substances may escape from the battery during charging and damage delicate surfaces. Store and charge in a suitable area.
- Ensure all vehicle accessories including lights, heaters, appliances etc are turned off prior to charging.
- This charger is not intended for use by persons (including children) with reduced physical, sensory or mental capabilities, or lack of experience and knowledge, unless they have been given supervision or instruction concerning use of the appliance by a person responsible for their safety.
- Young children should be supervised to ensure that they do not play with the appliance
- Only use the hanger bolts provided with the docking station to mount on the back of the charger

INDEX

1. Features	Page 4
1.1 Specifications	Page 6
1.2 Product Overview	Page 7
1.3 Assembly/Set Up	Page 9
2. Operation	Page 10
2.1 Setting Battery Voltage	Page 11
2.2 Pulse –Tronic Charge	Page 12
2.2.1 Charge Function Modes	Page 12
2.2.2.1 Storing Pulse-Tronic Charge	Page 14
2.2.2.2 Storing Supply/Diagnostic Mode	Page 14
2.3 Battery and Alternator Test	Page 15
2.3.1 Battery Test	Page 15
2.3.2 Charge System Test (Alternator)	Page 16
2.3.3 Battery Starting Charge Capacity (CCA)	Page 17
2.4 Battery Maintenance	Page 18
2.4.1 Desulfation	Page 19
2.4.2 Equalisation	Page 19
2.5 Power Supply	Page 21
2.5.1 Diagnostic	Page 22
2.5.2 Supply	Page 23
2.6 Engine Start	Page 25
2.6.1 Procedure	Page 25
2.7 Alarms	Page 26
3. FAQ's	Page 27

1. FEATURES

AUTOMATIC 8 STAGE CHARGING

Automatic 8 stage charging delivers a complete and thorough charge giving your batteries longer life & better performance. Once the battery is fully charged, the battery charger will continue to monitor the battery without the risk of overcharging.

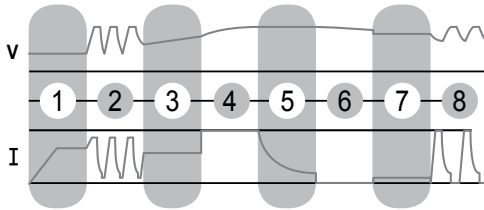

STAGE 1: Checks battery settings with battery

STAGE 2: Desulphation stage is designed to break down sulphation occurring in batteries that have been left flat for extended periods of time, returning them back to full charge. Sulphation occurs when lead-sulphate hardens and clogs up the battery cells.

STAGE 3: Soft Start, This is a preliminary charge process that gently introduces power to the battery, protecting the battery and increasing battery life.

STAGE 4: Bulk stage reduces charging time by charging the battery at the maximum rate (constant current) to a set voltage, at which point the battery is approximately 80% charged.

STAGE 5: Absorption stage charges the battery to 100% by adjusting the charge rate allowing the battery to absorb more power.

STAGE 6: Analysis mode tests the battery to ensure that it has taken the charge; if the battery passes the test the charger will proceed to the float stage, but if the battery fails the test, the charger will apply a recondition charge to return the battery to full charge.

STAGE 7: Float stage maintains the battery at 100% charge without overcharging or damaging the battery.

STAGE 8: Pulse Float, provides a long term storage charge to the battery by only providing charge when required.

ENGINE START FUNCTION

Starts vehicles with a flat battery after a controlled 5 minute charge.

LCD DISPLAY

The battery charger is fitted with an LCD digital display that displays the, battery voltage & Amp readings, correct connection and other warning messages during operation.

AUTO/MANUAL ADJUSTABLE OUTPUT

Manually or use the Automatic charge setting feature to adjust the rate of charge to best suit different battery sizes.

MULTI VOLTAGE OPERATION

Suitable for charging 6V, 12V & 24V batteries.

SHORT CIRCUIT & POLARITY PROTECTION

POWER SUPPLY MODE

Supply Power to the vehicle whilst the battery is being charged.

DIAGNOSTICS POWER SUPPLY

Supplies stabilised power to the vehicle's MCU whilst receiving software updates.

BATTERY CHEMISTRY SELECTION

The Multi-Chem function allows you to set the charging profile to suit each battery's chemistry type (GEL, AGM, WET and Calcium). This ensures correct and thorough charging and maximises battery performance and battery life. The following section describes the charge profiles for each chemistry type.

MANUALY SET EQUALISATION

Manually configure an Equalisation routine to balance all the cells of the battery.

MANUALY SET DESULPHATION

Manually perform Desulphation on the battery.

BATTERY AND ALTERNATOR TESTING

Test Battery Voltage.

Performs a check on the Alternator.

Checks the battery while starting.

SILENT MODE

The charger can run with the fan turned off where it is important for the charger to be running silent, like a car show room.

OPTIONAL 6 & 10 METRE LEADS

Optional 6 or 10 metre battery leads can be purchased for applications where longer leads are required.

1.1 SPECIFICATIONS

P/No. HDBM4000	6V	12V	24V
Type	8 Stage Automatic		
Input	240V, 50Hz, 600W		
Output	3-40A	3-40A	3-20A
Engine Start	–	70A for 3 sec	–
Minimum Start Voltage	2.0V	2.0V	2.0V
Charge Voltages (Absorption)			
AUTO	7.2V	14.4V	28.8V
AUTO ✱	7.7V	15.4V	30.8V
GEL	7.2V	14.4V	28.8V
AGM	7.35V	14.7V	29.4V
WET	7.7V	15.4V	30.8V
Calcium	8.0V	16.0V	32.0V
Float Voltage	6.7V	13.5V	27.0V
Back Drain	20mA	50mA	80mA
Approvals	Electrical Safety, EMC		

Type	6 & 12V Battery Range		24V Battery Range		Time		
	Automotive (CCA)	100	3700	100	2000	6	–
Marine (MCA)	120	4600	120	2300	8	–	18
Deep Cycle (AH)	14	600	14	300	7	–	17

1.2 PRODUCT OVERVIEW

Figure A



1. Display of the set battery voltage value.
2. Main display. Display: measured battery voltage, current, Ah selection, voltage value selected for the Supply / Diagnostic / Equalization programs, interface messages for the operator, alarm codes.
3. Polarity inversion, short circuit, worn out or faulty battery alarm.
4. Set current, voltage and Alarm codes "AL1 - AL9"
5. Battery charge level.
6. Choice of the Pulse Tronic charge current: AUTO, BOOST, Customised (Ah setting).
7. Low temperature function "COLD".
8. "SILENT NIGHT" function.
9. EQUALIZATION mode.
10. DESULFATION mode.

11. Choice of the battery production technology:
WET: lead-acid batteries with liquid electrolyte;
GEL: lead-acid batteries, sealed, with solid electrolyte;
AGM: lead-acid batteries, sealed, with electrolyte on absorbent material;
PbCa: lead-calcium batteries.
12. SUPPLY mode.
13. DIAGNOSTIC mode.
14. PULSE TRONIC charge process phases.
15. START mode.
16. Automatic charge mode.
17. Pulse Tronic charge.
18. Alternator Test Function.
19. Battery starting capacity test.
20. Battery charge status test.
21. BATTERY VOLTAGE – Settings button:
 - Battery voltage 6/12/24V.
 - Silent mode.
 - Voltage/Current adjustment.
22. MODE – Settings button:
 - Pulse Tronic CHARGE (AUTO, AUTO ✱, WET, GEL, AGM, PbCa).
 - TEST (battery status, vehicle alternator, battery starting capacity).
 - Advanced Programmes (DESULFATION, EQUALIZATION, DIAGNOSTIC, SUPPLY).
 - Voltage/Current adjustment.
23. CHARGE RATE – Settings button:
 - Output current (AUTO, BOOST, customised);
 - START mode.

1.3 ASSEMBLING CHARGING LEADS TO BATTERY CLAMPS

The HDBM400 battery charger is shipped with the battery clamps disconnected from the positive & negative charging leads.

IMPORTANT:

- The negative (Black) battery clamp must be connected to the charging lead with the black heat shrink on the lug.
- The positive (Red) battery clamp must be connected to the charging lead with the red heat shrink on the lug.

To connect both the positive and negative leads to the battery clamps refer to the instructions below:

1. Remove the M6 Dome head bolt from the clamp.
2. Fit the lug on the end of the charging lead to the battery clamp.
3. Tighten the lug.

1.3.1 CABLE CALIBRATION: the possibility of using different length charging cables requires initial calibration so as to compensate the drop in voltage along the cables.

CALIBRATION PROCEDURE

- press and hold the BATTERY VOLTAGE button (fig. A.21) and plug the cable into the mains socket;
- continue to hold the BATTERY VOLTAGE button (fig. A.21) until the digits “3 m” or “6 m” or “10 m” flash on the display;
- select the required value using the MODE button (fig. A.22);
- wait 5” for the selection to be confirmed.

INITIAL CONDITION



DEVICE OFF

Keep pressed the button "Battery Voltage" and plug into mains socket.
Release button "Battery Voltage" after 7".

BATTERY VOLTAGE

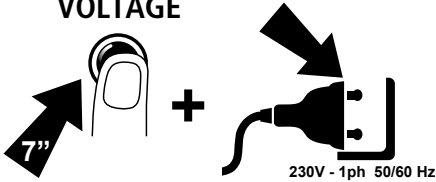

CABLE CALIBRATION

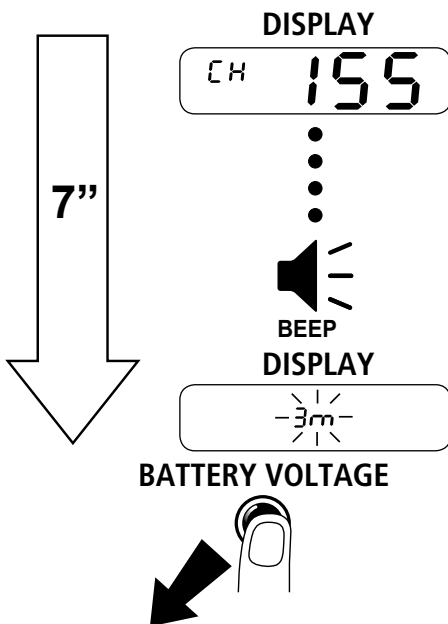

2. OPERATING INSTRUCTIONS

Follow the instructions in the order given below.

1. Remove the battery covers (if present), so that the gas produced during charging can exit.

- a. Make sure the level of electrolyte covers the battery plates; if they are not covered, add distilled water until they are submerged by 5–10 mm.

ATTENTION! BE VERY CAREFUL WHILE CARRYING OUT THIS OPERATION BECAUSE THE ELECTROLYTE IS AN EXTREMELY CORROSIVE ACID.

2. Check the polarity of the battery terminals: the (+) symbol is positive, the (-) symbol is negative.
3. Connect the red clamp to the positive terminal on the vehicle battery (+ symbol).
4. Connect the black clamp to the vehicle chassis. Do not connect near the fuel pipe.
5. If the battery is not installed inside the vehicle, directly connect to the negative battery terminal (- symbol).

Now the charger can be used to Charge a battery, Test the battery Voltage, Test the cranking of the vehicle, Test the alternator, Perform equalization, Sulphation and Power Supply modes (Diagnostic and Powersupply mode).

When finished using the charger

6. Disconnect the battery charger by removing the power cable from the mains socket.
7. Disconnect the black charge clamps from the vehicle or from the negative battery terminal (- symbol). Disconnect the red charging clamp from the positive battery terminal (+ symbol).
8. Return the battery charger to a dry place. Close the battery cells again, using the relative caps (if present).

2.1 SETTING BATTERY VOLTAGE

Use the "BATTERY VOLTAGE" button (fig. A.21), to set the rated voltage for the battery (fig. A.1) to be charged.

VOLTAGE SELECTION

BATTERY VOLTAGE

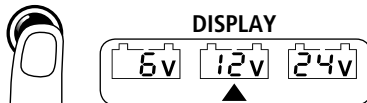

After connecting the clamps to the battery terminals:

- if the value detected is higher than the set value (fig. A.1), an "AL.2" error message (fig. A.2) is displayed;
- if the value detected is lower than the set value, the display (fig. A.1) starts to flash for 5 seconds giving time to change the voltage value displayed in (fig. A.1).

NOTE. The no battery connected status is indicated by the flashing (fig. A.5) symbol.

2.2 PULSE-TRONIC CHARGE

2.2.1 CHARGE FUNCTION MODES

There are various Pulse Tronic charge procedures that depend on the battery construction technology (T) and the charge current (C). When the battery is charged, the battery charger switches automatically to maintenance mode.

BATTERY TYPE SELECTION

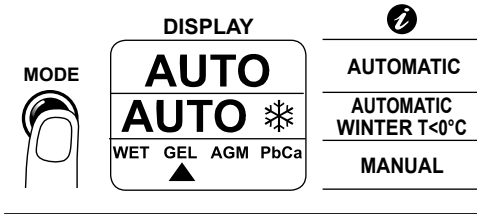

CURRENT SELECTION

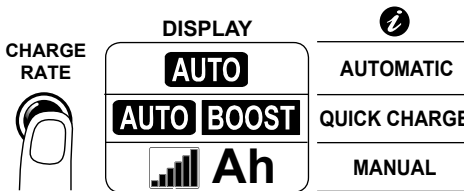

a) AUTOMATIC PULSE-TRONIC

(T) AUTO (C) AUTO

Both the identification of the battery construction technology (fig. A.16) and the current needed to charge it function in automatic mode (fig. A.6). This function mode is recommended when there is no information on the battery type.

b) AUTOMATIC PULSE-TRONIC AT LOW

TEMPERATURES (COLD fig. A.7)

(T) AUTO ❄️ (C) AUTO

Mode that improves the battery charge when the temperature is very low. Low temperature can influence the chemical structure of the battery components, therefore this function optimises the charge process according to this reduction in temperature.

This feature applies to the WET, AGM, PbCa batteries only.

When the battery is charged, the battery charger switches automatically to maintenance mode.

c) CUSTOMISED PULSE-TRONIC

It is possible to select:

- the battery construction technology (fig. A.11) choosing between: "WET, GEL, AGM, PbCa"
- the charge current (fig.A.6) choosing between: "AUTO" - automatic setting according to battery conditions; "BOOST" - rapid charge;
- the Ah - customised setting of the battery Ah (fig.A.2) using 6 predefined values selected using the "CHARGE RATE" button (fig. A.23), adjustable at 5 Ah intervals using the "BATTERY VOLTAGE" button (fig. A.21), and "MODE" (fig. A.22).

Ah SETTING – EXAMPLE

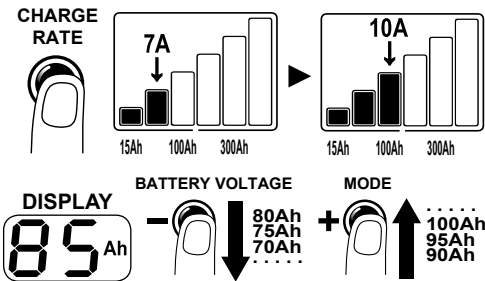

Charge Rate Amps	Amp hours	CCA
3	15	90
7	70	420
10	100	600
20	200	1200
30	300	1800
40	600	3600

Note. The final charge voltage depends on the technology of construction of the battery; to avoid damaging the battery, pay special attention to the technical specifications given by the manufacturer.

The PULSE TRONIC charge process (fig. A.17) starts when the display stops flashing, each individual phase is identified on the display (fig.A.14) and terminates with the message (fig. A.2) "OK". The battery charge status is displayed graphically in (fig. A.5). If the charge process is not successful, an alarm message appears on the display (fig. A.2) (see alarms list). When the battery is charged, the battery charger switches automatically to maintenance mode.

END OF CHARGE – EXAMPLE



CHARGE COMBINATION CHART

Battery Type (T)	Battery Current (C)
AUTO	Auto Auto Boost Manual 'Ah'
AUTO ✳	Auto Auto Boost Manual 'Ah'
WET, GEL, AGM, PdCa	Auto Auto Boost Manual 'Ah'

2.2.2 CHARGE FUNCTION MODES

It is possible to store the last function modes, so they are immediately available after any switching ON/OFF.

2.2.2.1 STORING PULSE-TRONIC CHARGE

Storage of voltage and type of battery, charge mode.

Procedure:

- Check that the charge clamps are not connected to a battery;
- Connect the power cable to the mains socket;
- Set the desired charge mode;
- Disconnect the power cable from the mains socket.

2.2.2.2 STORING SUPPLY/DIAGNOSTIC MODE

Storage of delivered voltage and current.

Procedure:

- Set the chosen mode and adjust the voltage/current values as required;
- Turn on the lock settings by pressing, at the same time, both keys "BATTERY VOLTAGE" (fig.A.21) and "CHARGE RATE" (fig.A.23) for 3 seconds, on the display (fig.A.2)(fig.A. 4) will appear "LOK on."

2.3 BATTERY AND ALTERNATOR TEST

The measurements can be performed with the battery connected to the vehicle, after connecting the clamps. Select the measurement to be performed using the "MODE" button (fig. A.22). On completing the test(s) disconnect the power cable from the mains socket and disconnect the clamps from the battery terminals.

NB: it is only possible to perform the tests without a power supply if the tests type selection is made after connecting the clamps to the battery terminals.

2.3.1 BATTERY TEST

Measure the voltage of the battery terminals.

BATTERY TEST SELECTION

MODE

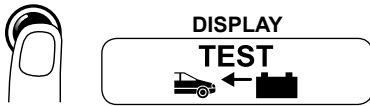

Procedure

- press the "MODE" button (fig. A.22) to select the function and the battery type (fig. A.20);
- connect the clamps to the battery terminals;
- press the "BATTERY VOLTAGE" button (fig. A.21) to select the battery voltage (fig. A.1);

The measured voltage is indicated on the display (fig. A.2) and the battery status is indicated in graph format (fig. A.5).

END OF TEST - EXAMPLE

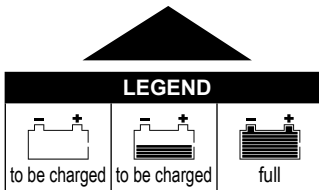
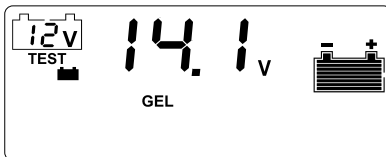

2.3.2 CHARGE SYSTEM TEST (ALTERNATOR)

Measure the voltage of the battery terminals.

ALTERNATOR TEST SELECTION

MODE



DISPLAY

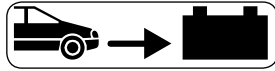

Procedure

- press the “MODE” button (fig. A.22) to select this function (fig. A.18); the message “Bad” appears on the display (fig. A.2);
- connect the clamps to the battery terminals;
- press the “BATTERY VOLTAGE” button (fig. A.21) to select the battery voltage (fig. A.1);
- switch on the engine, taking it to approx. 1500 rpm;
- switch on all the lights (full headlights, courtesy lights, etc.) and all the accessories at maximum level (air conditioning, radio, etc.);
- check the display (fig. A.2) to read the alternator functions and following status:
 - “OK” – CHARGING IN PROGRESS;
 - “SUF” – SUFFICIENT CHARGE;
 - “BAD” – INSUFFICIENT CHARGE.

END OF TEST – EXAMPLE



LEGEND		
OK	SUF	bad
working	sufficient	insufficient

2.3.3 BATTERY STARTING CHARGE CAPACITY (CCA)

Measure the voltage of the battery terminals.

CCA TEST SELECTION

MODE

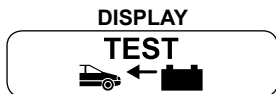

Procedure

- press the “MODE” button (fig. A.22) to select this function (fig. A.19);
- connect the battery terminal clamps, the message “Go” appears on the display (fig. A.2);
- press the “BATTERY VOLTAGE” button (fig. A.21) to select the battery voltage (fig. A.1);
- start the engine;
- check the display (fig. A.2) to read the battery starting capacity and the following status:
- “OK” - STARTING CAPACITY OK;
- “SUF” - SUFFICIENT STARTING CAPACITY;
- “BAD” - INSUFFICIENT STARTING CAPACITY.

END OF TEST – EXAMPLE



LEGEND		
OK	SUF	bAd
working	sufficient	insufficient

2.4 BATTERY MAINTENANCE

The device has two advanced operating modes for the maintenance of 6/12/24V batteries (ADVANCED PROGRAMS), press and hold the "MODE" button for 3 seconds (fig. A.22) recommended for AGM and WET type batteries:

- DESULFATION: recovery of sulphated batteries (fig. A.10);
- EQUALIZATION: reset of optimal battery conditions (fig. A.9).

ADVANCED MENU SELECTION

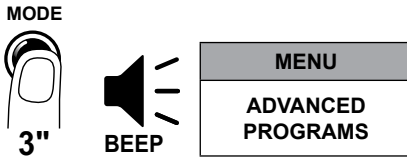

On completing the selected process, disconnect the power cable from the mains socket and disconnect the clamps from the battery terminals.

BUTTON LOCK. It is possible to lock and unlock the setting by simultaneously pressing and holding the "BATTERY VOLTAGE" (fig. A.21) and "CHARGE RATE" (fig. A.23) buttons for 3 seconds, and (fig. A.2) (fig. A.4) "LOK on" and "LOK off" will appear respectively on the display.

KEYBOARD LOCK

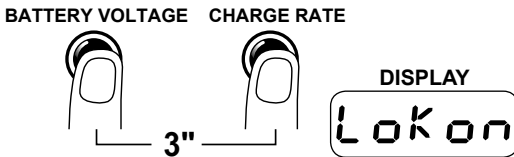

KEYBOARD UNLOCK

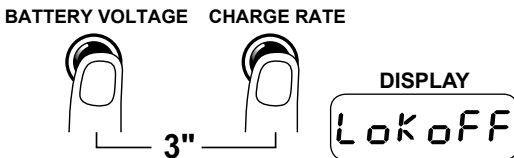

TO EXIT THE "ADVANCED PROGRAMS" MENU:

Press and hold the "MODE" button (fig. A.22) for 3 seconds.

EXIT – ADVANCED MENU

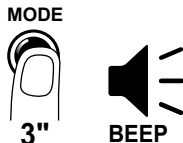

2.4.1 DESULFATION

Pulse system used to recover sulphated batteries by applying enough voltage to neutralise the surface layers of oxide and revitalize the underlying plates. It is advisable to perform this operation with the battery disconnected from the vehicle.

FUNCTION SELECTION

MODE



DISPLAY



ATTENTION! Pay particular attention to the nominal voltage of the battery which must correspond to the battery selected using the “BATTERY VOLTAGE” button and indicated on the display (fig. A.1).

Procedure

- press the “MODE” button (fig. A.22) to select this function (fig. A.10);
- press the “BATTERY VOLTAGE” button (fig. A.21) to select the battery voltage (fig. A.1);
- connect the clamps to the battery terminals;
- the process starts automatically, with a variable duration depending on the battery response, displayed in graph format. If the desulfation process is completed successfully the word “End” will appear on the display (fig. A.2). In the case of highly sulphated batteries, hence irrecoverable, this process may not be completed; this condition is indicated when the charge phase continues to restart and the opening/closing of a relay is audible.

END OF PROCESS – EXAMPLE

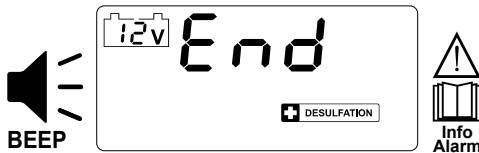

2.4.2 EQUALISATION

This process is recommended for routine battery maintenance, to be performed periodically according to use.

FUNCTION SELECTION

MODE



DISPLAY

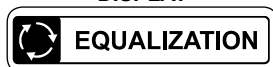

ATTENTION! Pay special attention to the type of battery being equalized (WET, GEL, AGM, PbCa): check the maximum allowed voltage to avoid damaging the same.

Customising the VOLTAGE

To customise the equalization voltage value simultaneously press and hold the "BATTERY VOLTAGE" (fig. A.21) and "MODE" (fig. A.22) buttons for 3 seconds, then use the same buttons to select (decrease using the "BATTERYVOLTAGE" button and increase using the "MODE" button), the desired voltage value between 6V-8.0V, 12V-16V, 24V-32V respectively for 6V, 12V, 24V batteries.

The factory default voltage value is respectively 6.8V, 13.6V, 27.2V.

The set voltage mode will be exited automatically after a 3" time-out.

VOLTAGE ADJUSTMENT – EXAMPLE

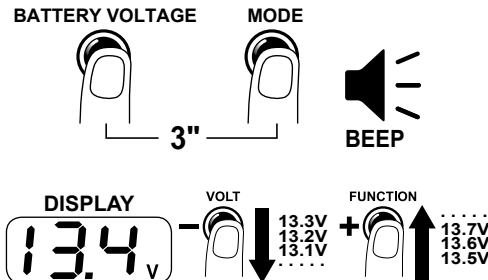

Procedure

- press the "MODE" button (fig. A.22) to select this function (fig. A.9);
- press the "BATTERY VOLTAGE" button (fig. A.21) to select the battery voltage (fig. A.1);
- connect the clamps to the battery terminals;
- the equalization process will run automatically indicating the voltage value on the display (fig.A.2), along with the current (fig. A.4) output. On completing the process, the word "End" will appear on the display (fig. A.2).

END OF PROCESS – EXAMPLE

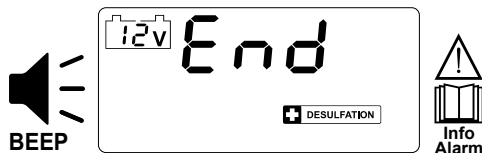

2.5 POWER SUPPLY

The device foresees 2 operating modes (ADVANCED PROGRAMS) as a generator stabilised at 6/12/24V:

- DIAGNOSTIC (fig. A.13);
- SUPPLY (fig. A.12).

ADVANCED MENU SELECTION

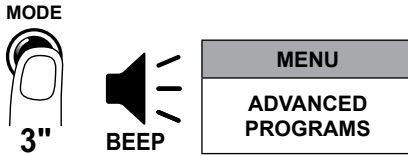

On completing the selected process, disconnect the power cable from the mains socket and disconnect the clamps from the battery terminals.

BUTTON LOCK. It is possible to lock and unlock the setting by simultaneously pressing and holding the "BATTERY VOLTAGE" (fig. A.21) and "CHARGE RATE" (fig. A.23) buttons for 3 seconds, and (fig. A.2) (fig. A.4) "LOK on" and "LOK off" will appear respectively on the display.

KEYBOARD LOCK

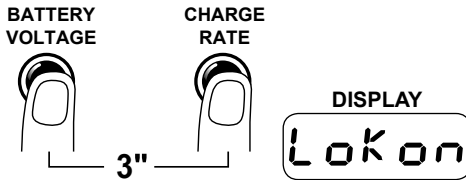

KEYBOARD UNLOCK

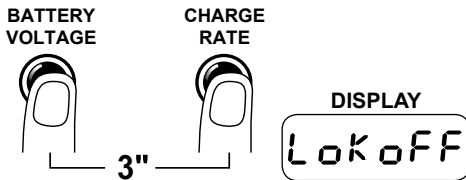

TO EXIT THE "ADVANCED PROGRAMS" MENU: Press and hold the "MODE" button for 3 seconds.

2.5.1 DIAGNOSTIC

Disturbance free precision power for supporting the battery during the vehicle electric system diagnostic operations (function used mainly in workshops).

FUNCTION SELECTION

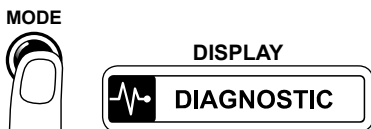

The set voltage is present on the charge clamps when connected to the battery.

NOTE. The battery must not be disconnected from the vehicle (so as not to lose the setup settings) and must have a minimal voltage of 5V to guarantee the correct functioning of the process.

ATTENTION! Check the maximum permissible voltage on the vehicle manufacturer's technical specifications to prevent damage to the on-board electronics and the battery.

Customising VOLTAGE and CURRENT

VOLTAGE

- press and hold simultaneously the "BATTERY VOLTAGE" (fig.A.21) and "MODE" buttons (fig. A.22) for 3 seconds;
- use the same buttons to select (decrease using the "BATTERY VOLTAGE" button and increase using the "FUNCTION" button) the desired voltage value between 6V-7.5V, 12V-15V, 24V-30V respectively for 6V, 12V, 24V batteries; the factory default voltage value is respectively 6.8V, 13.6V, 27.2V.

The set voltage mode will be exited automatically after a 3" time-out.

VOLTAGE ADJUSTMENT – EXAMPLE

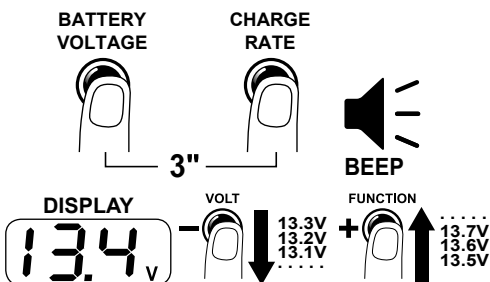

CURRENT

- press the “CHARGE RATE” button (fig. A.23) until the desired value, set as indicated in step 6, appears on the display (fig. A.4) and on the icon (fig. A.6). The set current mode will be exited automatically after a 3” time-out.

CURRENT ADJUSTMENT – EXAMPLE

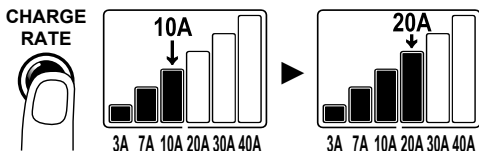

PROCEDURE

- press the “MODE” button (fig. A.22) to select this desired function (fig. A.13 or fig. A.12); - if necessary or requested by the vehicle manufacturer specifications, customise the voltage and/or current values as indicated below;
- use the “BATTERY VOLTAGE” button to select the battery voltage;
- connect the clamps to the relative vehicle battery terminals;
- the process will run automatically indicating the voltage value on the display (fig. A.2), along with the current (fig. A.4) after 5 seconds from the last operation.

DISPLAY – EXAMPLE

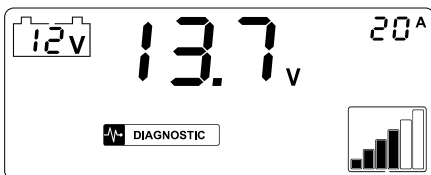

2.5.2 SUPPLY

Constant voltage generator that can be used on BATTERY CHANGES or on batteries with a very low voltage (below 2V) to try to increase their voltage to a value that is suitable for starting with a normal charge cycle.

FUNCTION SELECTION

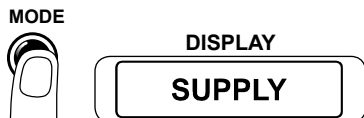

ATTENTION! The set voltage is always present on the charge clamps even when disconnected from the battery.

ATTENTION! Pay particular attention to the nominal voltage of the battery which must correspond to the voltage selected using the “VOLT” button and indicated on the display (fig. A.1). This function **DOES NOT HAVE** spark protection on the output clamps and reverse polarity protection.

Customising VOLTAGE and CURRENT

VOLTAGE

- press and hold simultaneously the “BATTERY VOLTAGE” (fig.A.21) and “MODE” buttons (fig. A.22) for 3 seconds
- use the same buttons to select (decrease using the “BATTERY VOLTAGE” button and increase using the “MODE” button) the desired voltage value between 6V-7.5V, 12V-15V, 24V-30V respectively for 6V, 12V, 24V batteries; the factory default voltage value is respectively 6.8V, 13.6V,27.2V.

The set voltage mode will be exited automatically after a 3” time-out.

VOLTAGE ADJUSTMENT – EXAMPLE

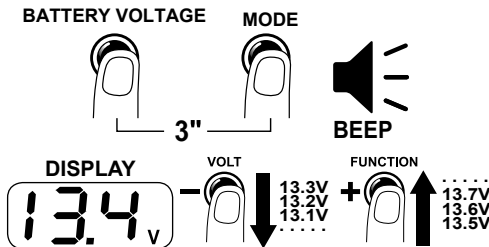

CURRENT

- press the “CHARGE RATE” button until the desired value, set as indicated in step 6, appears on the display (fig. A .4) and on the icon (fig. A.6). The set current mode will be exited automatically after a 3” timeout.

CURRENT ADJUSTMENT – EXAMPLE

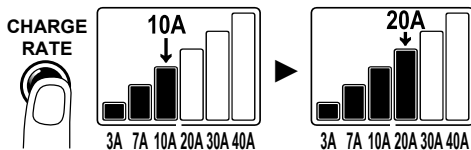

CHANGE BATTERY Procedure

- Press the “MODE” button (fig. A.22) to select the SUPPLY function (fig. A.12);
- if necessary or requested by the vehicle manufacturer specifications, customise the voltage and/or current values as indicated above;
- press the “BATTERY VOLTAGE” button (fig. A.21) to select the battery voltage (fig. A.1);
- connect the clamps to the relative vehicle battery terminals;
- change the battery paying particular attention not to disconnect the clamps from the vehicle terminals so as not to lose the electronic settings.

2.6 ENGINE START – START

START mode (fig. A.15), is available for 12V batteries and supplies 70 A current as a starter aid. If the battery is completely run down, it is advisable to perform a pre-charge cycle before proceeding.

FUNCTION SELECTION

CHARGE
RATE



DISPLAY



2.6.1 Procedure

- Press and hold the “CHARGE RATE” button (fig. A.23) for 3 seconds to select the “ENGINE START” function;
- connect the vehicle battery terminal clamps (the flashing message “Go” appears on the display (fig.A.1));
- now start the vehicle; a 30 second timer will engage and will appear on the display (fig. A.1), at the end of which it will be possible to start the engine again;
- on completing the selected process, disconnect the power cable from the mains socket and disconnect the clamps from the battery terminals.

FUNCTION EXIT

CHARGE
RATE



2.7 ALARMS

The alarms are displayed by a graph symbol (fig. A.3) when there is reverse polarity, short circuit, low or faulty battery.

The alarms will appear on the display (fig. A.2) and have the following meanings:

AL1: Reverse polarity and short circuit;

AL2: Battery voltage incompatible with selection;

AL3: PULSE TRONIC charge: has not completed the Desulphation within the 4 hour time limit, battery may not be recoverable.

AL4: PULSE TRONIC charge: has not completed Soft Start within the 4 hour time limit. The battery may not be recoverable;

AL5: PULSE TRONIC charge: has not completed bulk charge within the 18 hour time limit - The battery may not be recoverable;

AL6: PULSE TRONIC charge: The battery voltage dropped below 12.5V during analysis stage.

AL7: PULSE TRONIC charge: when the battery voltage is extremely low (<4.5V for 6V, <9.0V for 12V, <18.0 for 24V), the battery charger has 4 hours get above these voltages.

AL8: PULSE TRONIC charge: The battery has failed during Pulse Float. The battery may not be recoverable;

AL9: Short circuit in Supply / Diagnostic /Equalization functions.

3 FREQUENTLY ASKED QUESTIONS

Q. Why does the LCD screen indicate a fully charged battery straight away?

- A. There are two possible reasons why the LCD display may indicate a fully charged battery ('OK') straight away.
1. The battery is fully charged.
 2. The battery has taken a surface charge.

Q. What is Surface Charge?

- A. Batteries unused or left flat for some time build up a resistance to being recharged. When the charger is first connected, these batteries will take a surface charge, and the LCD display will indicate a fully charged battery within a short while. The battery however is not fully charged, the charger is voltage sensitive and cannot differentiate between a surface charge and a fully charged battery. After a few hours the battery may start to accept some charge but most batteries with this condition will not recover.

Q. What is a Faulty Cell?

- A. 12 Volt batteries contain 6 cells and one faulty cell is enough to ruin your battery. If after eight hours of charging your battery is still flat, you should test the cells using a hydrometer. If one reading is lower than the rest it indicates a faulty cell. It is pointless to continue charging, as the battery needs replacing.

Q. What are Volts and Amps?

VOLTS

The term voltage refers to the electrical force or electric potential to do work between two terminals or a good analogy is water pressure in a pipe. For example a battery has 12 Volts between the positive and negative terminals.

AMPS

The term AMPS is the unit of measure used for current. This can be described as the flow of electric charge in a circuit. Again if you use the water analogy this would refer to how much water is flowing through the pipe. For example if the current is reading 12 Amps then this is the amount of energy going into the battery.

WARRANTY STATEMENT

Applicable only to product sold in Australia

Brown & Watson International Pty Ltd of 1500 Ferntree Gully Road, Knoxfield, Vic., telephone (03) 9730 6000, fax (03) 9730 6050, warrants that all products described in its current catalogue (save and except for all bulbs and lenses whether made of glass or some other substance) will under normal use and service be free of failures in material and workmanship for a period of one (1) year (unless this period has been extended as indicated elsewhere) from the date of the original purchase by the consumer as marked on the invoice. This warranty does not cover ordinary wear and tear, abuse, alteration of products or damage caused by the consumer.

To make a warranty claim the consumer must deliver the product at their cost to the original place of purchase or to any other place which may be nominated by either BWI or the retailer from where the product was bought in order that a warranty assessment may be performed. The consumer must also deliver the original invoice evidencing the date and place of purchase together with an explanation in writing as to the nature of the claim.

In the event that the claim is determined to be for a minor failure of the product then BWI reserves the right to repair or replace it at its discretion. In the event that a major failure is determined the consumer will be entitled to a replacement or a refund as well as compensation for any other reasonably foreseeable loss or damage.

This warranty is in addition to any other rights or remedies that the consumer may have under State or Federal legislation.

IMPORTANT NOTE

Our goods come with guarantees that cannot be excluded under the Australian Consumer Law. You are entitled to a replacement or refund for a major failure and compensation for any other reasonably foreseeable loss or damage. You are also entitled to have the goods repaired or replaced if the goods fail to be of acceptable quality and the failure does not amount to a major failure.

Distributed by

AUSTRALIA

Brown & Watson International Pty Ltd

Knoxfield, Victoria 3180

Telephone (03) 9730 6000

Facsimile (03) 9730 6050

National Toll Free 1800 113 443

NEW ZEALAND

Narva New Zealand Ltd

22–24 Olive Road

PO Box 12556 Penrose

Auckland, New Zealand

Telephone (09) 525 4575

Facsimile (09) 579 1192