

CHARACTERISTICS

Nominal Voltage		12V
Nominal Capacity (20 hour rate)		260Ah
Capacity 25°C	10 hour rate (9.0A)	234Ah
	5 hour rate (15.9A)	207Ah
	1 hour rate (55.4A)	144.1Ah
Internal Resistance	Full Charged Battery 25°C	≤1.6mΩ
Capacity affected by Temperature (10 hour)	40°C	102%
	25°C	100%
	0°C	85%
	-15°C	65%
Self-Discharge 25°C Capacity	after 3 month storage	90%
	after 6 month storage	80%
	after 12 month storage	62%
Charge (Constant Voltage) 25°C	Float	Initial Charging Current Less than 52A Voltage 13.6-13.8V
	Cycle	Initial Charging Current Less than 52A Voltage 14.4-14.9V



PACKAGING

Battery Dimensions	Length	520mm
	Width	268mm
	Height	220mm
	Total Height	226mm
Box Dimensions	Length	537mm
	Width	284mm
	Height	299mm
Quantity Per Box	1 PC per box	
Net weight Per Cell	77.0 kg±3%	
Net weight Per Box	77.0kg	
Gross Weight	78kg	

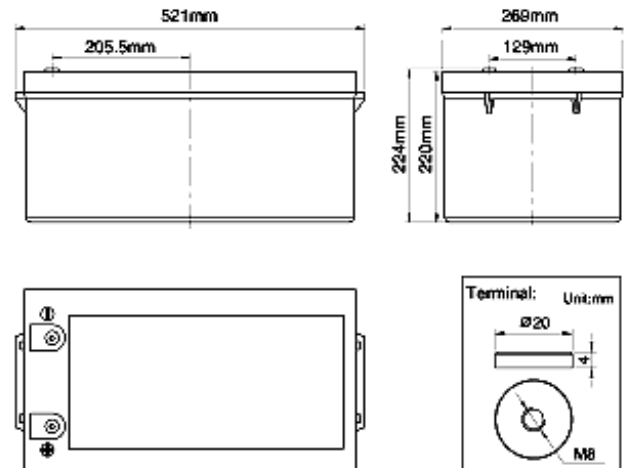

Discharge Constant Current per Cell (Amperes at 25°C)

F.V/Time	5min	10min	15min	30min	45min	1h	2h	3h	5h	8h	10h	20h
1.60V	617.8	393.8	334.6	213.6	157.0	144.1	91.6	64.4	43.8	28.8	25.7	14.3
1.65V	606.5	386.7	328.5	209.8	154.2	141.5	90.0	63.2	43.0	28.3	25.3	14
1.70V	595.3	379.5	322.5	205.9	151.3	138.9	88.3	62.0	42.2	27.8	24.8	13.8
1.75V	584.1	372.3	316.4	202.0	148.4	136.3	86.6	60.8	41.4	27.3	24.3	13.5
1.80V	561.6	358.0	304.2	194.2	142.7	131.0	83.3	58.5	39.8	26.2	23.4	13.00

Discharge Constant Current per Cell (Watts at 25°C)

F.V/Time	5min	10min	15min	30min	45min	1h	2h	3h	5h	8h	10h	20h
1.60V	1189.2	758.1	644.1	411.3	302.3	277.5	176.4	123.9	84.2	55.5	49.5	27.5
1.65V	1167.6	744.3	632.4	403.8	296.8	272.4	173.2	121.6	82.7	54.5	48.6	27.0
1.70V	1145.9	730.5	620.7	396.3	291.3	267.4	170.0	119.4	81.2	53.5	47.7	26.5
1.75V	1124.3	716.8	609.0	388.8	285.8	262.3	166.8	117.1	79.6	52.5	46.8	26.0
1.80V	1081.1	689.2	585.6	373.9	274.8	252.3	160.4	112.6	76.6	50.5	45.0	25.0

Note: The above data are average values, and can be obtained within 3 charge/discharge cycles. These are not minimum values. Cell and battery designs/specifications are subject to modification without notice. Contact R&J for the latest information.

PERFORMANCE CHARACTERISTICS

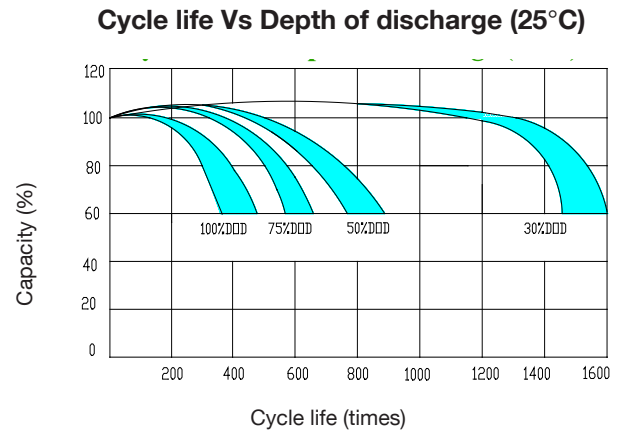
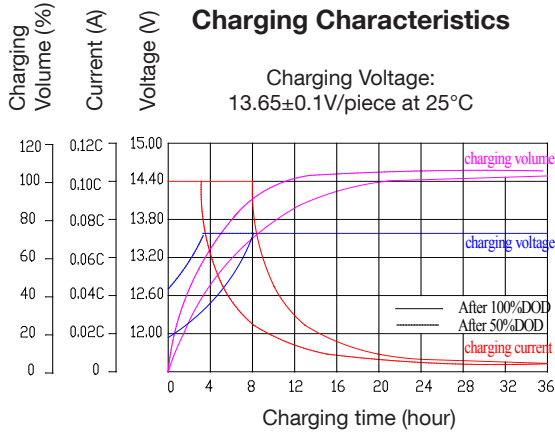

Temperature effect on designed float life

Float charging Voltage: 13.65±0.01V/piece at 25°C

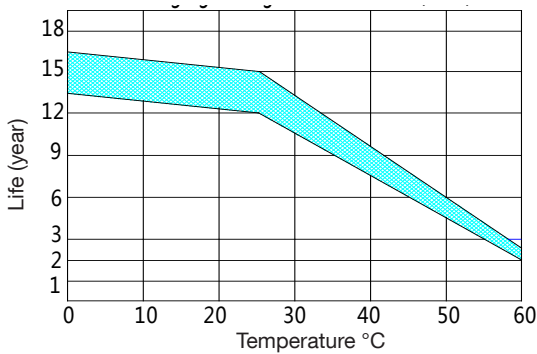

Discharge characteristics (25°C)

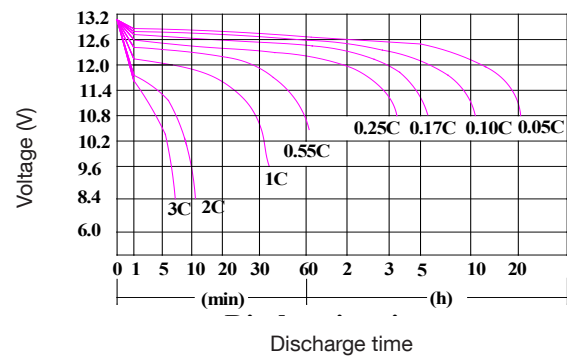

Temperature effect on battery self-discharge

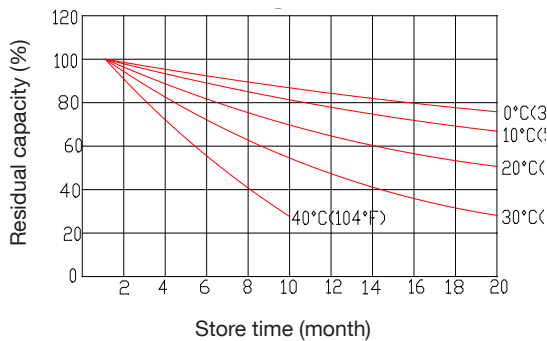

Temperature effect on capacity

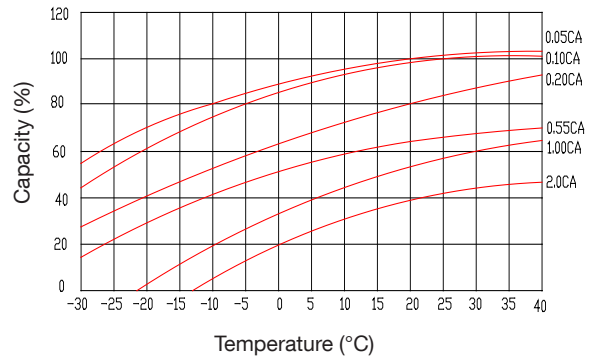

BATTERY CONSTRUCTION

Component	Positive plate	Negative plate	Container	Cover	Safety valve	Terminal	Separator	Electrolyte
Raw material	Lead dioxide	Lead	ABS	ABS	Si-Rubber	Copper	Fiberglass	Sulfuric acid